

EE 2240
Homework Problem #030

- a. Assign mesh currents and express the mesh equations in the matrix form discussed in class.

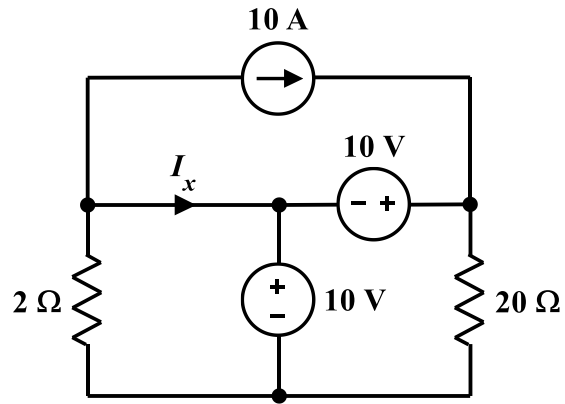

- b. Use MATLAB to solve the equations and determine the value of I_x . Show your work.